



Cordless Hole Puncher PP001G



40V Li-ion max

Automatic punch return

After a punching cycle is completed, hydraulic pressure automatically pulls off the punch from workpiece and returns it to the initial position to enable efficient continuous hole punching.

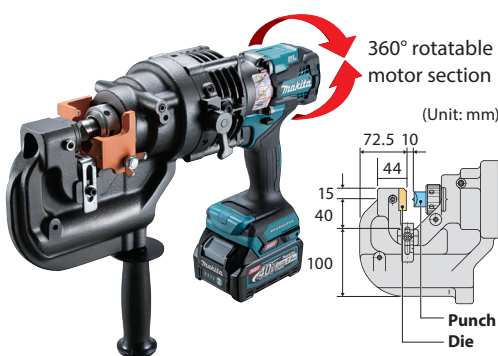
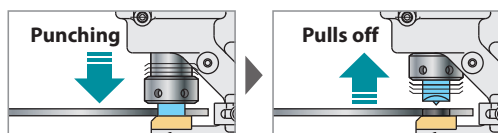

Compact design

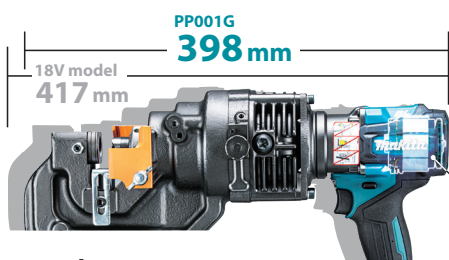

Return lever

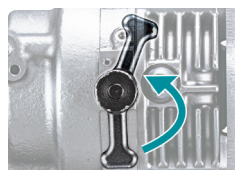

Portable and hydraulic (No need for hydraulic pressure hose)

High-efficiency punching

Working time reduced by about

46%

compared with our 18V model

Max punching capacity

Cutting material:
General steel (SS400)

ø 20

t 9 mm

ø 19

t 10 mm

Compatible with various steel materials

Punching capacity

Material	Capacity
Flat bar	Max: 80mm x t9 (Center punching)
Angle	Min: 40mm x 40mm x t3 Max: 80mm x 80mm x t9
Channel	Min: 75mm x 40mm Max: 125mm x 65mm (Flange punching)
H-steel	Min: 100mm x 100mm Max: 300mm x 150mm

Flat bar



Angle



Channel

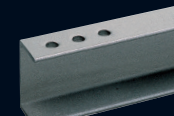

H-steel

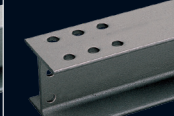

Accessories

Combination of punch and die

- Punching holes through a thin structural metal plate may cause deformation of the plate and burr on the holes.
- If you need precision punching, see the tables below to select an optimum combination of punch and die.

Round punching

Oblong punching



Round punching										
Punch		Die		Cutting material		Die		Cutting material		
Hole size (mm)	Part No.	Hole size	Part No.	Mild Steel	Aluminum	Hole size	Part No.	Mild Steel	Stainless Steel (Inox)	Channel
6	SC05340040	SA6	SC00000202	t2-t3.2	t2-t3.2	SB6	SC00000203	t2-t4	t3-t4	-
6.5	SC05340050	SA6.5	SC00000204	t2-t3.2	t2-t3.2	SB6.5	SC00000205	t2-t6	t3-t4	-
8	SC05340060	SA8	SC00000206	t2-t3.2	t2-t3.2	SB8	SC00000207	t2-t6	t3-t4	-
8.5	SC05340070	SA8.5	SC00000208	t2-t3.2	t2-t3.2	SB8.5	SC00000209	t2-t6	t3-t4	-
10	SC05340080	SA10	SC00000210	t2-t3.2	t2-t3.2	SB10	SC00000211	t2-t6	t3-t4	t8
11	SC05340090	SA11	SC00000212	t2-t3.2	t2-t3.2	SB11	SC00000213	t3-t9	t3-t6	t8
12	SC05340100	SA12	SC00000214	t2-t3.2	t2-t3.2	SB12	SC00000215	t3-t9	t3-t6	t8
13	SC05340110	SA13	SC00000216	t2-t3.2	t2-t3.2	SB13	SC00000217	t3-t9	t3-t6	t8
14	SC05340120	SA14	SC00000218	t2-t3.2	t2-t3.2	SB14	SC00000219	t3-t9	t3-t6	t8
15	SC05340130	SA15	SC00000220	t2-t3.2	t2-t3.2	SB15	SC00000221	t3-t9	t3-t6	t8
16	SC05340140	-	-	t2-t3.2	t2-t3.2	SB16	SC05332710	t3-t9	t3-t6	t8
18	SC05340150	SA18	SC00000222	t2-t3.2	t2-t3.2	SB18	SC00000223	t3-t9	t3-t6	t8
19	SC05340170	-	-	-	-	SB19	SC05332740	t3-t9	t3-t6	t8
20	SC05340160	SA20	SC05352500	t2-t3.2	t2-t3.2	SB20	SC05352510	t3-t9	t3-t6	t8

Round punching						
Punch		Die		Cutting material		
Hole size (mm)	Part No.	Hole size	Part No.	Mild Steel	Stainless Steel (Inox)	Channel
-	-	-	-	-	-	-
-	-	-	-	-	-	-
-	-	-	-	-	-	-
-	-	-	-	-	-	-
-	-	-	-	-	-	-
-	-	-	-	-	-	-
-	-	-	-	-	-	-
12	SC05340400	SB12	SC00000215	t10	t3-t6	t10
13	SC05340410	SB13	SC00000217	t10	t3-t6	t10
14	SC05340420	SB14	SC00000219	t10	t3-t6	t10
15	SC05340430	SB15	SC00000221	t10	t3-t6	t10
16	SC05340440	SB16	SC05332710	t10	t3-t6	t10
18	SC05340450	SB18	SC00000223	t10	t3-t6	t10
19	SC05340460	SB19	SC05332740	t10	t3-t6	t10
20	-	-	-	-	-	-

Oblong punching										
Punch		Die		Cutting material		Die		Cutting material		
Hole size (mm)	Part No.	Hole size	Part No.	Mild Steel	Aluminum	Hole size	Part No.	Mild Steel	Stainless Steel (Inox)	Channel
6.5x10	SC05340200	A6.5x10	SC00000243	t2-t3.2	t2-t3.2	B6.5x10	SC00000244	t2-t6	t3-t4	-
6.5x13	SC05340210	A6.5x13	SC00000245	t2-t3.2	t2-t3.2	B6.5x13	SC00000246	t2-t6	t3-t4	-
8.5x13	SC05340220	A8.5x13	SC00000247	t2-t3.2	t2-t3.2	B8.5x13	SC00000248	t2-t6	t3-t4	-
8.5x17	SC05340230	A8.5x17	SC00000249	t2-t3.2	t2-t3.2	B8.5x17	SC00000250	t2-t6	t3-t4	-
9x13.5	SC05340240	A9x13.5	SC00000251	t2-t3.2	t2-t3.2	B9x13.5	SC00000252	t2-t6	t3-t4	-
9x18	SC05340250	A9x18	SC00000253	t2-t3.2	t2-t3.2	B9x18	SC00000254	t2-t6	t3-t4	-
10x15	SC05340260	A10x15	SC00000255	t2-t3.2	t2-t3.2	B10x15	SC00000256	t2-t8	t3-t6	t8
10x20	SC05340270	A10x20	SC00000257	t2-t3.2	t2-t3.2	B10x20	SC00000258	t2-t8	t3-t6	t8
11x16.5	SC05340280	A11x16.5	SC00000259	t2-t3.2	t2-t3.2	B11x16.5	SC00000260	t2-t9	t3-t6	t8
12x18	SC05340290	A12x18	SC00000261	t2-t3.2	t2-t3.2	B12x18	SC00000262	t2-t9	t3-t6	t8
13x19.5	SC05340300	A13x19.5	SC00000263	t2-t3.2	t2-t3.2	B13x19.5	SC00000264	t2-t9	t3-t6	t8
14x21	SC05340310	A14x21	SC00000265	t2-t3.2	t2-t3.2	B14x21	SC00000266	t2-t9	t3-t6	t8
15x21	SC05340320	-	-	-	-	B15x21	SC05340550	t2-t9	t3-t6	t8

Vertical oblong punching						
Punch		Die		Cutting material		
Hole size (mm)	Part No.	Hole size	Part No.	Mild Steel	Stainless Steel (Inox)	Channel
20x12	SC05340350	B20x12	SC05340510	t2-t9	t3-t6	t8/t7.5
20x14	SC05340360	B20x14	SC05340530	t2-t9	t3-t6	t8/t7.5

Accessories

Hydraulic oil ISO46

Part No.	Part No.	Part No.
SC00000106	SC00000142	SC00000270
35mL	150mL	1,000mL



Work stand set

Part No. SC03801080



Slide stopper

Part No. SC03300790

Punching up to 40 mm depth from the edge of the workpiece can be done using the optional slide stopper.

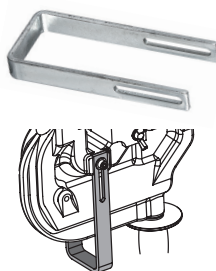

Charging Time

Battery	Fast Charging	
	DC40RA	DC40RC
*1 BL4020 2.0Ah	22 min	30 min
*1 BL4025 2.5Ah	28 min	38 min
*1 BL4040/F 4.0Ah	45 min	67 min
*1 BL4050F 5.0Ah	50 min	85 min
*1 BL4080F 8.0Ah	76 min	170 min

*1 Recommended battery

Cordless Hole Puncher

PP001G

Capacity	Steel: 20 mm Stainless steel: 20 mm
Sound pressure level	77 dB(A)
Noise K factor	3 dB(A)
Vibration level	2.5 m/s ² or less
Vibration K factor	1.5 m/s ²
Dimensions (L x W x H)	w/ BL4020 / BL4025: 398 x 129 x 315 mm (15-5/8 x 5-1/8 x 12-3/8")
Net weight	11.6 - 12.8 kg (25.6 - 28.2 lbs.)
Net weight (Battery)	BL4020 - BL4080F

Carrying Case	Standard Equipment :
	Punch, Die, Grip, Bar for fastening nuts, Hex wrench, Wrench

The weight may differ depending on the attachment(s), including the battery cartridge.
Items of standard equipment and specifications may vary by country or area.

Makita Corporation

3-11-8 Sumiyoshi-cho, Anjo, Aichi, 446-8502 Japan



PRINTED IN JAPAN 202408

www.makita.com