











# SPECIFICATIONS

	JR3060T	JR3070CT
Rating Amperage for Noth America	12 A	15 A
Continuous rating Input	1,250 W	1,510 W
Capacities (when 300 mm blade used)	in pipe : $\phi$ 130 mm (5-1/8") in wood : 255 mm (10")	in pipe : $\phi$ 130 mm (5-1/8") in wood : 255 mm (10")
Length of stroke	32 mm (1-1/4")	32 mm (1-1/4")
Strokes per min.	0-2,800	0-2,800
Orbital function	Yes	Yes
Speed control	No	Yes
Constant speed	No	Yes
AVT	No	Yes
Vibration	14 m / s <sup>2</sup>	9 m / s <sup>2</sup>
Dimensions (L x W x H)	485 mm x 99 mm x 181 mm (19-1/8" x 3-7/8" x 7-1/8")	485 mm x 99 mm x 181 mm (19-1/8" x 3-7/8" x 7-1/8")
Net weight	4.2 kg (9.3 lbs)	4.3 kg (9.5 lbs)
Power supply cord standard equipment	2.5 m (8.2 ft.) Recipro saw blade (3pcs.)	2.5 m (8.2 ft.) Recipro saw blade (3pcs.)

Specifications may differ from country to country.  
Items of standard equipment may differ from country to country.

# OPTIONAL ACCESSORIES

Recipro saw blade							
A : Includes nail embedded wood.							
Blade type	Teeth per inch	Overall length (mm)	application	Type	Pc. per pkg.	Part No	
No.21		24	120	For steel plate 3 mm thick or less. For iron pipe 50 mm dia. or less.	-	5 2	792146-3 B-00804
No.22		18	160	For steel plate, aluminum sash more than 3 mm thick. For iron pipe 90 mm dia. or less.	-	5 2	792147-1 B-00810
No.23		9	160	Wood cutting under 90 mm.	A	5 2	792148-9 B-00826
No.23B		6	160	Wood cutting under 90 mm. For fast finish work.	-	5	792707-9
No.24		24	160	For steel plate 3 mm thick or less. For iron pipe 50 mm dia. or less.	-	5 2	792149-7 B-00832
No.3019		4	150	For roughing-in work in thick wood.	-	5	A-02303
No.3020		10	150	For wood, plywood. 5	A	5	A-02319
No.3022		6	150	For scroll cutting of plywood and other laminates.	-	5	A-02331
No.3023		10	250	For wood, plywood.	-	5	B-00767
No.3030		6	300	For roughing-in work in thick wood.	-	5	B-03030



## Recipro Saw JR3060T, JR3070CT

new

# Cutting Edge

# AVT™

ANTI VIBRATION TECHNOLOGY

AVT : Model JR3070CT only





*Muscle*  
■ JR3060T ■

# "Cutting Edge" Brothers



■ JR3070CT ■  
*Big Brother*

## JR3060T

Comparison of efficiency : cutting wood  
Blade used : Standard equipped blade of each brand

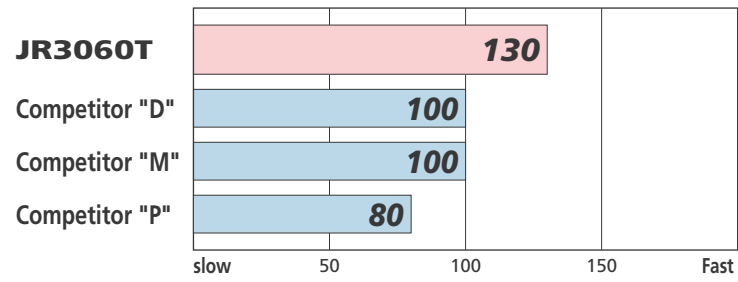

## JR3070CT

Comparison of efficiency : cutting carbon steel pipe  
Blade used : Standard equipped blade of each brand

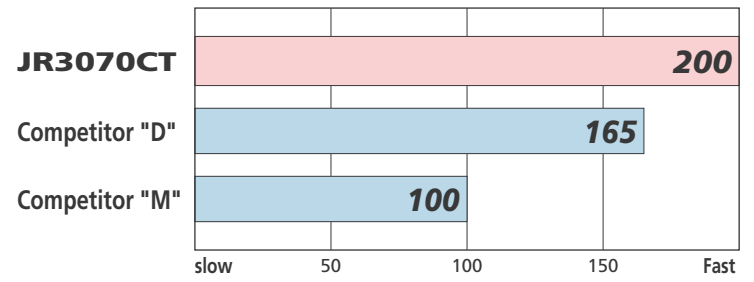

Note : Numbers in the chart are relative values when the capacity of competitor "M" is indexed at 100.

### Dust Proof Design No.1



Air from inside prevent the dust collected around slider.

### Dust Proof Design No.2

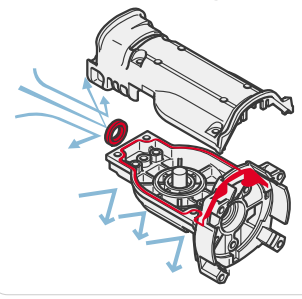

Ring, and Rubber Seal protect gear room against dust.



### Orbital Action

Selectable its degree with this lever for faster cutting in thick materials.

### Constant Speed

Built-in controller maintains constant stroke speed under operational load. (JR3070CT only)

### Large Trigger

for easier control

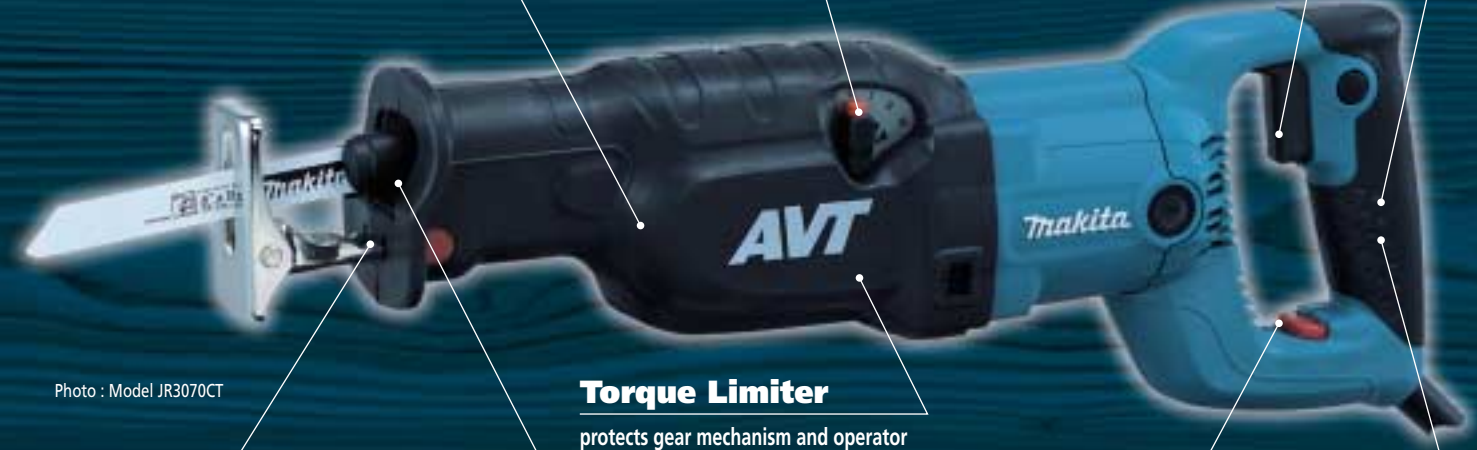

Photo : Model JR3070CT

### Torque Limiter

protects gear mechanism and operator against accidental blade lock-up.

### Soft Grip

for your comfort

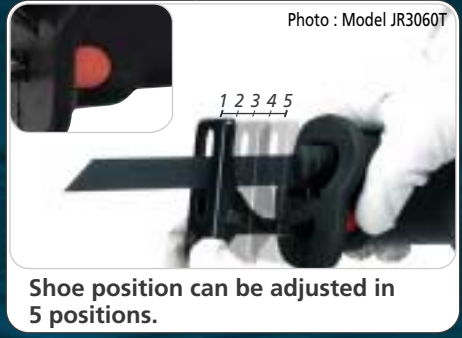

Photo : Model JR3060T

Shoe position can be adjusted in 5 positions.

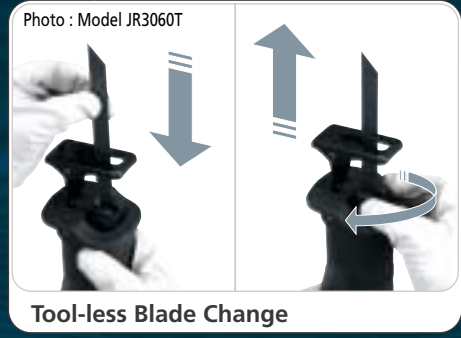

Photo : Model JR3060T

Tool-less Blade Change



### Preset Dial for Speed Control

Enables to select the optimal stroke speed for application. (JR3070CT only)

# AVT™

ANTI VIBRATION TECHNOLOGY



**EXTRA COMFORT with AVT**

## Extra-Low Vibration achieved by Counter Weight Mechanism

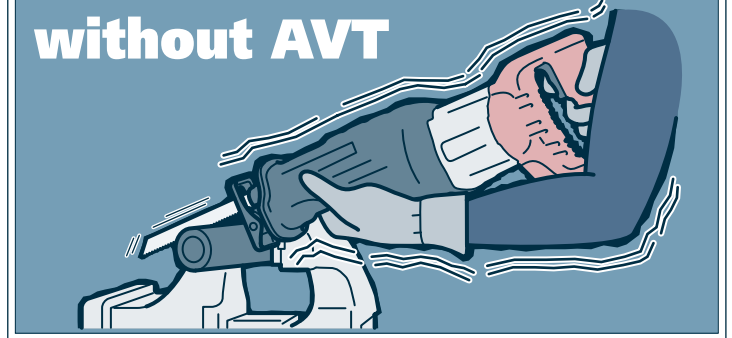
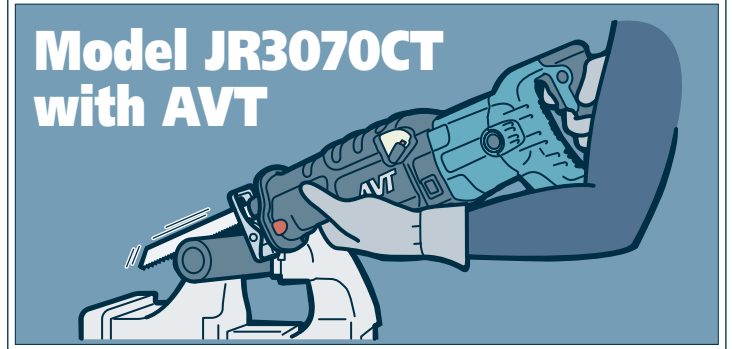
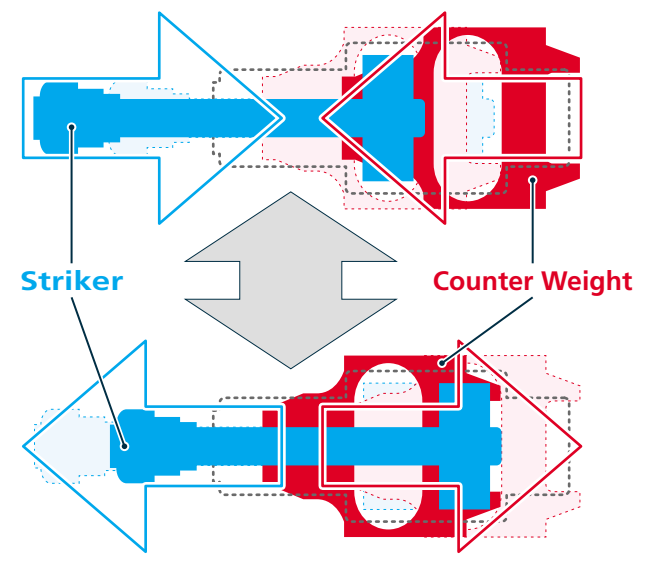

**VIBRATION 50% CUT**

AVT featured JR3070CT only : Vibration 9 m/s<sup>2</sup>  
Against Makita's predecessor model JR3020 and equivalent model of competitor "M" under operational load.